



Spare Parts for Refrigeration equipment



Spare parts suitable for

MONDIAL

2018

Find the complete and up-to-date range of products in our GEV Webshop

heating elements

heating elements for refrigeration

heating elements for defrosting



GEV No.	419137	Ref. No.	4003116147000
description	heating element 1100W 230V L 1000mm W 70mm cable length 1800mm tube ø 8.5mm defrosting		

thermostats

refrigeration thermostats

RANCO

K50 series

RANCO



GEV No.	390988	Ref. No.	1101031
description	thermostat RANCO type K50B-S3508 probe ø 2mm capillary pipe 1500mm		

RANCO



GEV No.	390780	Ref. No.	1001086
description	thermostat RANCO type K50-L3085 probe ø 6mm probe Lmm capillary pipe 1800mm temperature range -4 up to -32°C NO		

RANCO



GEV No.	390528	Ref. No.	1101043
description	thermostat RANCO type K50-L3417 probe ø 10mm probe L 100mm capillary pipe 1400mm probe ø9.5x112mm		

RANCO



GEV No.	390803	Ref. No.	1101005
description	thermostat RANCO type K50-P1569/001 probe L 50mm capillary pipe 900mm		

K54 series

RANCO



GEV No.	390782	Ref. No.	1001118 1101001G
description	thermostat RANCO type K54-L2097 probe ø 2mm capillary pipe 900mm		

ATEA



GEV No.	390794	Ref. No.	1101028
description	thermostat ATEA type A01 0806 probe ø 10mm probe L 52mm capillary pipe 1150mm		

switches and momentary switches

rocker/momentary rocker switches



30x22mm





GEV No.	301002	Ref. No.	1014056
description	rocker switch mounting measurements 30x22mm orange 2NO 250V 16A illuminated 0-I connection male faston 6.3mm ambient temperature max. 85/125°C protection IP65		

accessories for	301002			
	GEV No.	301036	Ref. No.	—
	protective cover internal size 30x22mm for rocker switch mounting measurementsmm			



 <p>1</p>			
GEV No.	301009	Ref. No.	1114014
description	rocker switch mounting measurements 30x22mm white 2NO 250V 16A illuminated 0-I connection male faston 6.3mm ambient temperature max. 125/55°C protection IP65		
accessories for	301009		
			
GEV No.	301036	Ref. No.	—
description	protective cover internal size 30x22mm for rocker switch mounting measurementsmm		

 <p>1</p>			
GEV No.	346377	Ref. No.	1014073
description	rocker switch mounting measurements 30x22mm black 2CO 230V 16A 0-I connection male faston 6.3mm ambient temperature max. 125/55°C protection IP40		
accessories for	346377		
			
GEV No.	301036	Ref. No.	—
description	protective cover internal size 30x22mm for rocker switch mounting measurementsmm		

 <p>Image not available</p> <p>1</p>			
GEV No.	301287	Ref. No.	1114001G 1114018
description	rocker switch mounting measurements 30x22mm orange 2NO 250V 16A illuminated 0-I connection male faston 6.3mm ambient temperature max. 100/55°C protection IP40		

push/momentary push switches

<p>ø16mm</p>  <p>1</p>			
GEV No.	301295	Ref. No.	1114013
description	push switch mounting ø 16mm black 1NO 250V 16A connection male faston 6.3mm protection IP40 ambient temperature max. 150°C		

microswitches

with push button

switches with snap-fit

 <p>1</p>			
GEV No.	348148	Ref. No.	1195012
description	microswitch with push button 250V 0.25A 1NO connection male faston 6.3mm L 26x12mm ambient temperature max. 85°C actuating force: 500g		
For models:	EBA01W540		

roller actuated

roller 90°



 <p>1</p>			
GEV No.	347640	Ref. No.	1095001
description	microswitch with roller plunger 250V 16A connection male faston 6.3mm ambient temperature max. 85°C thread M12		

lamps

indicator lights

indicator lights (complete)

30x22mm

 <p>1</p>			
GEV No.	359157	Ref. No.	1111002G
description	indicator light mounting measurements 30x22mm 230V green connection male faston 6.3mm temp.-resist. 125/55°C type RL2		
accessories for	359157		
			
GEV No.	301036	Ref. No.	—
description	protective cover internal size 30x22mm for rocker switch mounting measurementsmm		

fluorescent lamps

fluorescent lamps

G13

 <p>1</p>			
GEV No.	359371	Ref. No.	1112007
description	fluorescent lamp socket G13 L 590mm 18W 230V Qty 1 pcs		



relays

power relays

with bracket mounting



1

GEV No.	380815	Ref. No.	1142005
description	power relays 230VAC 16A 2NO connection male faston 6.3mm flange dimensions 36x38x68mm		

electronic controllers

DIXELL

refrigeration controllers

built-in version



1

GEV No.	378307	Ref. No.	1188054
description	electronic controller DIXELL XR40C-5N1C1 mounting measurements 71x29mm 230V voltage AC NTC/PTC relay outputs 2 NO-20A(8) CO-8A(3) NTC/PTC DI protection IP54 0-60°C display 3½ digits		

TECNOLOGIC

universal controllers

built-in version



1

GEV No.	379796	Ref. No.	1188053
description	electronic controller TECNOLOGIC type TLZ11FR--21 mounting measurements 71x29mm 12V voltage AC/DC NTC/PTC relay outputs 1 CO-8A(3) NTC/PTC DI built-in depth 64mm defr. funct. no -50 up to +150°C display 4 digits		

refrigeration controllers

built-in version



1

GEV No.	379796	Ref. No.	1188053
description	electronic controller TECNOLOGIC type TLZ11FR--21 mounting measurements 71x29mm 12V voltage AC/DC NTC/PTC relay outputs 1 CO-8A(3) NTC/PTC DI built-in depth 64mm defr. funct. no -50 up to +150°C display 4 digits		



1

GEV No.	378519	Ref. No.	1188179
description	electronic controller TECNOLOGIC type Y39SE mounting measurements 71x29mm 100-240V voltage AC NTC/PTC relay outputs 3 NO-16A CO-10A NO-5A NTC/PTC NTC/PTC DI front measurements 78x35mm built-in depth 64mm protection IP65 yes yes defr. funct. yes -50 up to +150°C display 3 digits		

fans

axial fans

import



1

GEV No.	601510 ¹	Ref. No.	4021019
description	axial fan L 119mm W 119mm H 38mm 230VAC 50/60Hz 22/21W bearing ball bearing connection male faston 6.3mm SUNON temp.-resist. 70°C		

¹with ball bearings





refrigeration fans

cold air circulating fans

cold air circulating fans



GEV No.	750398	Ref. No.	4121093
description	fan motor 230/240V 50/60Hz 35W shaft ø 6mm shaft L 14mm W 62mm H 73mm		
accessories for	750398		
	GEV No.	601413	Ref. No. —
	fixing plate suitable for fanwheel ED ø 32mm shaft ø 7 mounting distance 26mm		
	GEV No.	602184	Ref. No. —
	fixing plate suitable for fanwheel ED ø 33mm shaft ø 6 mounting distance 17mm		

cross flow fans

EMMEVI - FERGAS

with standard coil



GEV No.	602070	Ref. No.	4022150
description	cross flow fan 116299 roller ø 60mm roller length 180mm laminated core thickness 20mm 220/240V - 50/60Hz 28W bearing rubber connection male faston 6.3mm		

equipmentspecific units

for fridges

miscellaneous



GEV No.	694849	Ref. No.	1721625
description	cover with sump for evaporator L 390mm W 355mm H 140mm plastic		

handles and hand wheels

bracket handles

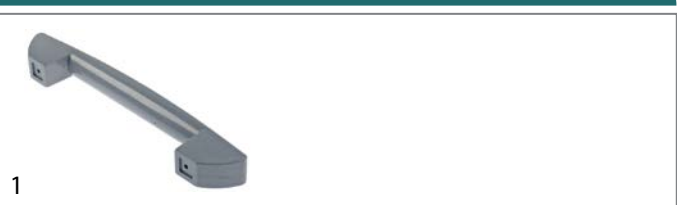

GEV No.	502270	Ref. No.	1721369
description	pull handle L 300mm H 50mm mounting distance 218mm hole ø 5mm grey		
accessories for	502270		
	GEV No.	692567	Ref. No. 1721370
	cover L 295mm H 26mm ABS plastic		

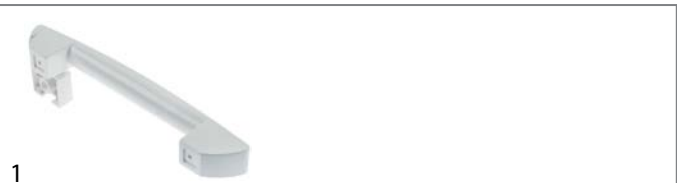



GEV No.	502268	Ref. No.	1721349
description	pull handle L 300mm H 50mm mounting distance 218mm hole ø 5mm white		



GEV No.	502269	Ref. No.	1721343
description	pull handle L 300mm H 50mm mounting distance 218mm hole ø 5mm white		

covers

			
1			
GEV No.	692566	Ref. No.	1721345
description	cover L 295mm H 26mm ABS plastic		

			
1			
GEV No.	692567	Ref. No.	1721370
description	cover L 295mm H 26mm ABS plastic		
accessories for	692567		
	GEV No.	502270	Ref. No. 1721369
	pull handle L 300mm H 50mm mounting distance 218mm hole ø 5mm grey		

recessed handles

			
1			
GEV No.	692568	Ref. No.	17210674
description	recessed handle L 120mm W 40mm H 22mm mounting distance 80mm ABS plastic		

			
1			
GEV No.	692569	Ref. No.	1721039
description	recessed handle L 140mm W 30mm H 25mm mounting distance 80mm ABS plastic		

			
1			
GEV No.	692571	Ref. No.	1721373
description	recessed handle L 250mm W 40mm H 20mm ABS plastic		

locks

locking devices

producer-specific

MONDIAL

			
1			
GEV No.	692209	Ref. No.	5601058
description	key cylinder with slide latch ø 17mm thread M4 cam length 76mm cam width 13mm thread L 5.5mm		

shelves and shelf rails

grates

producer-specific

			
1			
GEV No.	970549	Ref. No.	0621130
description	grate W 448mm D 453mm steel with layer RILSAN white suitable for refrigerator with hinge camp		

			
1			
GEV No.	970491	Ref. No.	0621140
description	grate W 518mm D 408mm plastic-coated steel		

gaskets

refrigeration gaskets

plug-in gaskets

profile 9050

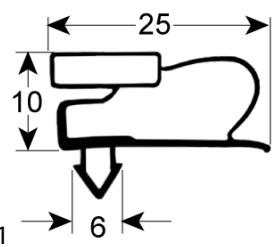
			
1			
GEV No.	901441	Ref. No.	4612003
description	refrigeration gasket profile 9050 W 518mm L 1627mm plug size L1 1640mm W1 531mm external size		



profile 9773

We offer custom-made gaskets for this profile

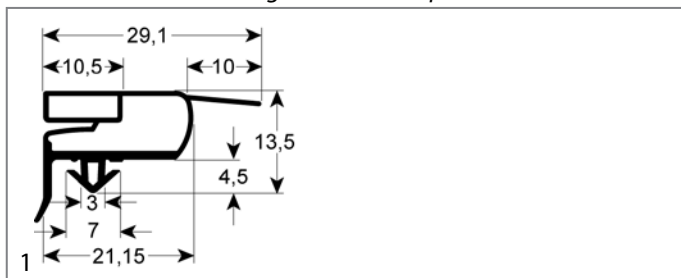

GEV No.	901782	Ref. No.	4612040
description	refrigeration gasket profile 9773 W 507mm L 1627mm plug size		

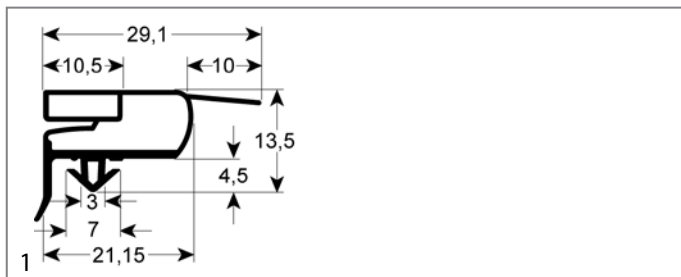

GEV No.	901090	Ref. No.	4612084
description	refrigeration gasket profile 9773 W 553mm L 1442mm plug size		

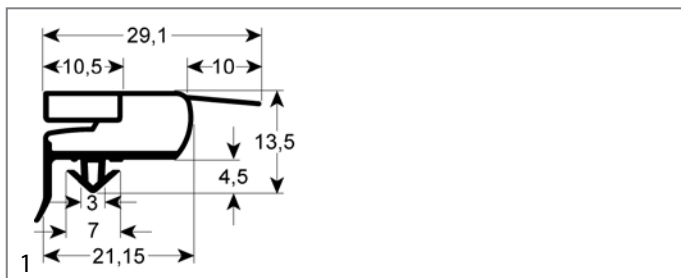

GEV No.	901088	Ref. No.	4612082
description	refrigeration gasket profile 9773 W 553mm L 1692mm plug size		

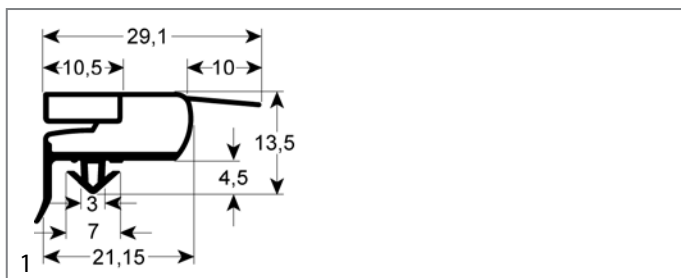

GEV No.	901334	Ref. No.	4612135
description	refrigeration gasket profile 9773 W 558mm L 732mm plug size		

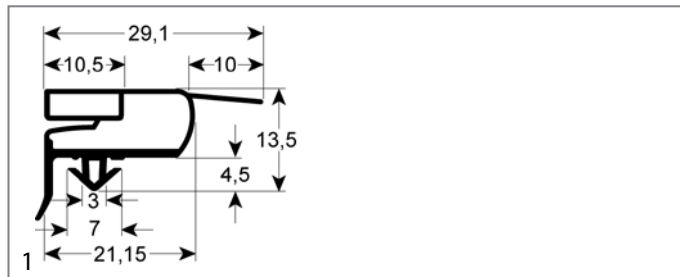

GEV No.	901487	Ref. No.	4612091
description	refrigeration gasket profile 9773 W 622mm L 1517mm plug size		

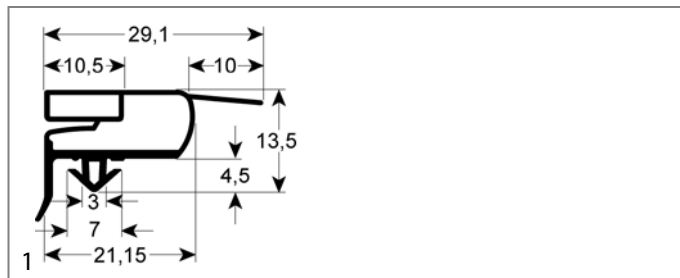

GEV No.	901781	Ref. No.	4612120
description	refrigeration gasket profile 9773 W 622mm L 1517mm plug size		

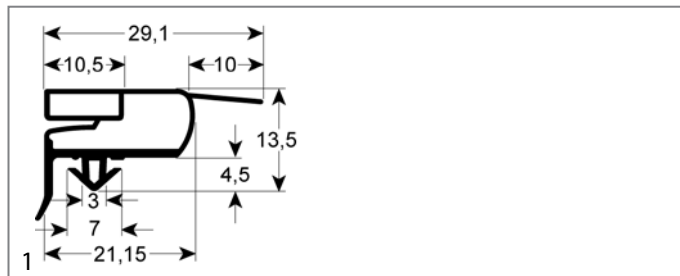

GEV No.	901089	Ref. No.	4612038
description	refrigeration gasket profile 9773 W 627mm L 1527mm plug size		

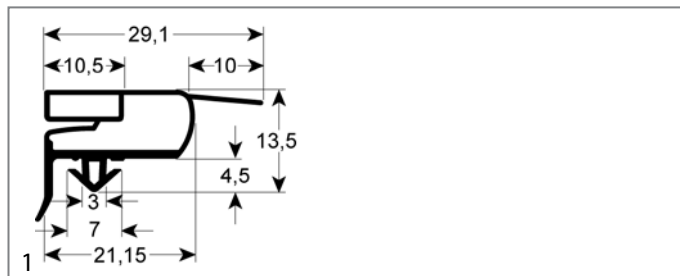

GEV No.	901783	Ref. No.	4612041
description	refrigeration gasket profile 9773 W 692mm L 1627mm plug size		

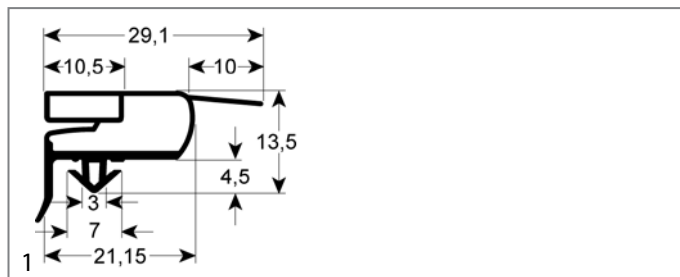

GEV No.	901087	Ref. No.	4612083
description	refrigeration gasket profile 9773 W 727mm L 1687mm plug size		

mechanical components, equipment accessories

GEV No.	901977	Ref. No.	4612039
description	refrigeration gasket profile 9773 W 736mm L 1540mm plug size suitable for MONDIAL		

profile 9151
We offer custom-made gaskets for this profile

GEV No.	901098	Ref. No.	4612069
description	refrigeration gasket profile 9151 W 565mm L 1690mm plug size		

GEV No.	901174	Ref. No.	4612138
description	refrigeration gasket profile 9151 W 572mm L 1709mm external size L1 1699mm W1 562mm plug size		

GEV No.	902127	Ref. No.	4612156
description	refrigeration gasket profile 9151 W 632mm L 1525mm plug size grey		

GEV No.	902114	Ref. No.	4612155
description	refrigeration gasket profile 9151 W 632mm L 1525mm plug size white		

GEV No.	901093	Ref. No.	4612005
description	refrigeration gasket profile 9151 W 720mm L 1655mm plug size L1 1645mm W1 710mm external size		

GEV No.	901168	Ref. No.	4612139
description	refrigeration gasket profile 9151 W 737mm L 1699mm plug size		

GEV No.	901092	Ref. No.	4612068
description	refrigeration gasket profile 9151 W 755mm L 1705mm plug size L1 1695mm W1 745mm external size		

GEV No.	902115	Ref. No.	4612154
description	refrigeration gasket profile 9010 W 643mm L 1407mm plug size		

GEV No.	901091	Ref. No.	4512017
description	refrigeration gasket profile 9010 W 650mm L 1545mm plug size		

profile 9010
We offer custom-made gaskets for this profile

GEV No.	902115	Ref. No.	4612154
description	refrigeration gasket profile 9010 W 643mm L 1407mm plug size		

GEV No.	901091	Ref. No.	4512017
description	refrigeration gasket profile 9010 W 650mm L 1545mm plug size		

GEV No.	901091	Ref. No.	4512017
description	refrigeration gasket profile 9010 W 650mm L 1545mm plug size		



evaporators

for fridges

producer-specific



GEV No.	750354	Ref. No.	4133007
description	evaporator L 1000mm W 470mm Hmm suitable for BEV/KIC		



GEV No.	750627	Ref. No.	4132069
description	evaporator L 335mm W 95mm H 275mm total length 355mm for fridge		

measuring equipment

thermometers

built-in thermometers



GEV No.	541081	Ref. No.	2531018
description	thermometer mounting measurements 58x25.5mm -40 up to +40°C capillary pipe 1500mm probe ø 8mm probe L 22mm		

battery powered



GEV No.	379798	Ref. No.	1188017
description	thermometer mounting measurements 47x27mm battery comp. rear -40 up to +70°C cable length 2000mm white		
accessories for	379798		
	GEV No.	379808	Ref. No.
			—
	frame for thermometer internal size 47x27mm W 53mm H 33mm D 17mm lug length 11mm hole distance 64.2mm		

A

axial fans 4

C

cold air circulating fans 5

cross flow fans 5

E

electronic controllers 4

evaporators 9

F

fans 4

fluorescent lamps 3,3

G

grates 6

H

heating elements 2

heating elements for defrosting 2

heating elements for refrigeration 2

I

indicator lights 3

indicator lights (complete) 3

L

lamps 3

M

measuring equipment 9

microswitches 3

P

plug-in gaskets 6

push/momentary push switches 3

R

refrigeration fans 5

refrigeration gaskets 6

refrigeration thermostats 2

relays 4

rocker/momentary rocker switches 2

S

shelves and shelf rails 6

switches and momentary switches 2

T

thermostats 2